

INSTALLATION NOTES

Curaflex® gasket inserts

- Curaflex® C/2/SD/6
- Curaflex® F/2/SD/6
- Curaflex® C/2/SD/5
- Curaflex® F/2/SD/5

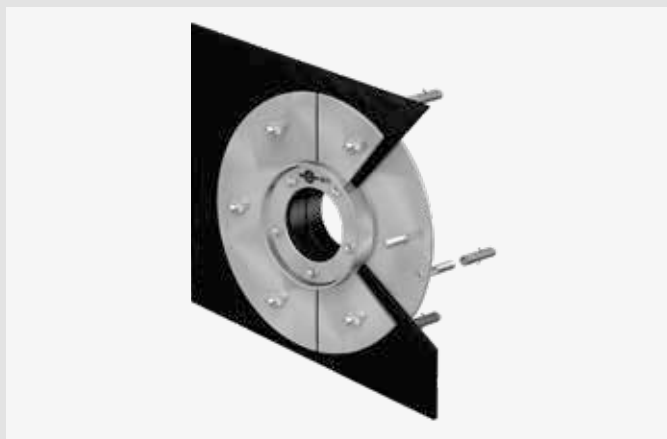

Curaflex® C/2/SD/6

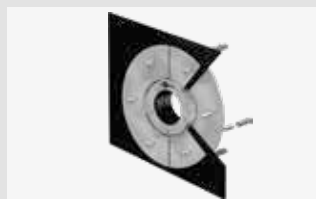

Curaflex® F/2/SD/6

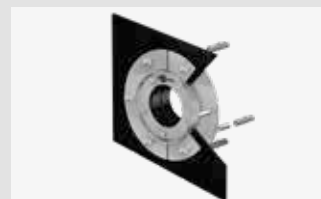

Curaflex® C/2/SD/5

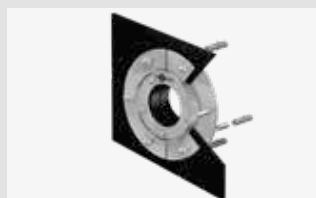

Curaflex® F/2/SD/5

Dear Customer,

Thank you for choosing a quality product from our range.

Please read this message and the included installation instructions in full before installing or processing our products and keep both in a safe place after installation.

Safety instructions:

- Our products may only be installed by persons with the necessary specialist knowledge.
- For your own protection and the protection of third parties, the work area and any necessary pipe trenches must be properly constructed and secured in accordance with the applicable regulations.
- When installing our sealing and fire protection systems, the recognised rules of technology, the relevant regulations of the employers' liability insurance associations, the VDE regulations and the applicable safety and accident regulations must be observed. Parts of the body may be crushed or other serious injuries may occur when tensioning or fixing the products in place.
- The safety data sheets must be observed.
- Check that the delivered product is complete (the scope of delivery is listed separately in the installation instructions) and check all individual parts for any damage. Only undamaged parts may be installed.
- Check that the product is suitable for its intended use using the installation instructions. If there are any particular demands,

please clarify the use of the product with us in advance. Request our checklists for this purpose or download them from www.doyma.com.

Any liability on our part is excluded for misuse!

- Finally, please observe the instructions for the tools and equipment required for installation.

Industrial property rights:

- Our industrial property rights and those of third parties must be observed.

Disposal:

- Please observe the applicable regulations when disposing of components, accessories and packaging.

Terms and conditions of sale:

- The current version of our terms and conditions of sale and delivery shall prevail.

- Curaflex® C/2/SD/6
- Curaflex® F/2/SD/6
- Curaflex® C/2/SD/5
- Curaflex® F/2/SD/5

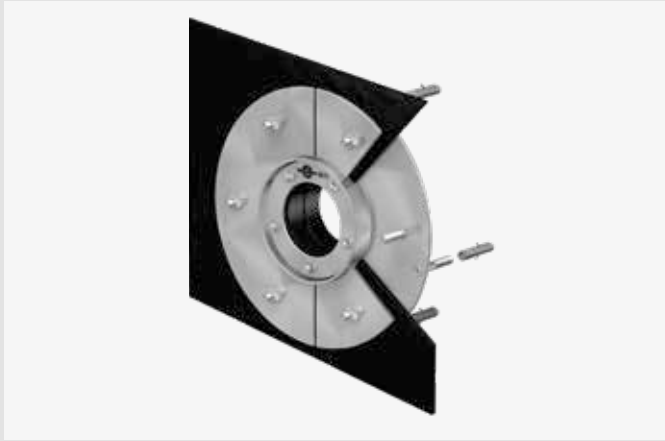

Curaflex® C/2/SD/6

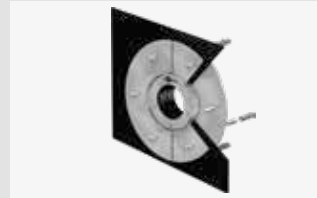

Curaflex® F/2/SD/6

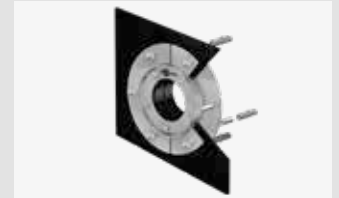

Curaflex® C/2/SD/5

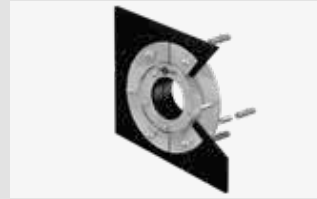

Curaflex® F/2/SD/5

Intended use

Curaflex® C/2/SD-5/-6 and F/2/SD-5/-6 fixed/loose flange constructions made of steel are suitable for waterproofing buildings with tanking membranes or thick coating (black tank) in accordance with DIN 18195/DIN 18533/DIN 18535. All models are suitable for installation on the wall/ceiling/floor. Curaflex® gasket inserts are used to safely seal the annular space between the core bore/pipe sleeve and the media pipe/cable/smooth-walled cable conduit to be installed.

Please note

- Curaflex® gasket inserts are maintenance-free. Once correctly installed, it is not necessary to re-tighten the bolts.
- Before installation, compare the diameters of the pipe and pipe sleeve/core bore with the specifications on the gasket insert.
- Gasket inserts are not secure points or support bearings; they are only used for elastic sealing of pipes.
- Slight axial movements of the pipes are permitted.
- The relevant FHRK standard (minimum seal width) must be taken from the product label.
- When installing the sealing system, the applicable accident prevention regulations, VDE rules, the applicable national health and safety regulations, and the rules and policies of your company must all be observed.
- The applicable national regulations governing the laying and filling of pipes and cables must be observed.

Scope of delivery

- Curaflex® gasket insert with fixed and loose flange (when using thick coating in sanded version)
- Fixing material
- Installation notes

Accessories (optional)

Accessories for thick coating (only for sanded version): Curaflex® 1776 spacer rings and rubber O-rings, fibre glass matting
Accessories for use with thin and/or hard tanking membranes: Curaflex® 1775 packings (one set contains two EPDM packings)

Installation conditions

- Breakouts, cracks and/or cavities in waterproof concrete core bores should be smoothed in advance.
- Pipe sleeves must be rigid enough to withstand the compressive forces from the gasket insert and must have a smooth, circular inner surface. If pipe sleeves are damaged they must first be tested in advance for usability.
- Sealing components for the media pipe/cable/cable conduit must be installed in a waterproof concrete core bore or a pre-installed pipe sleeve.
- The media line (cable or pipe) to be sealed must be cleaned in advance and must not have any axial depressions or elevations in or around the sealing area.
- Compact the substrate and pipe substructure well before laying the pipe/cable, so that no sinking is possible.
- In addition to the usual standard tool, you also need the following tools and equipment in order to properly install the gasket insert:

Tools:

- 1 torque spanner
- 1 extension
- 1 hexagon socket
(for size, see installation steps)
- 1 punch tool
(for size, see installation steps)

Equipment:

- Lubricant
- Cleaning agent (solvent-free)
- Calliper gauge
- Cleaning cloth

- The wall in the installation area of the fixed flange must be clean, even, dust-free and dry.
- No cracks or breakouts may be present on the wall surface in the area of the fixed flange.
- The fixed and loose flange must be clean and free of dust and grease.
- Distances for flange constructions in accordance with DIN 18195/DIN 18533 must generally be arranged as follows: Flange edge to flange edge or to other components, e.g. building edges and channels, wall connections, not less than 150 mm for non-pressing water and not less than 300 mm for pressing water. For expansion joints, distances of at least 300 mm must be maintained for non-pressing water and at least 500 mm for pressing water, unless a greater distance is required for processing reasons.

- Curaflex® C/2/SD/6
- Curaflex® F/2/SD/6
- Curaflex® C/2/SD/5
- Curaflex® F/2/SD/5

Installation steps

Curaflex® C (F)/2/SD/5 or C(F)/2/SD/6 with tanking membranes/-packings

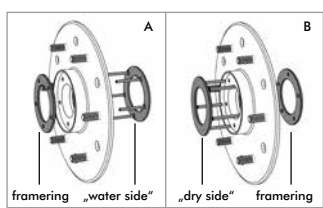

Swapping the frame rings makes it possible to change the tensioning side of the gasket insert (changing the tensioning option of the gasket insert from the "water side" to the "dry side" and vice versa). Curaflex® C/2/SD/6 or C/2/SD/5 (Option A) is switched to Curaflex® F/2/SD/6 or F/2/SD/5 (Option B).

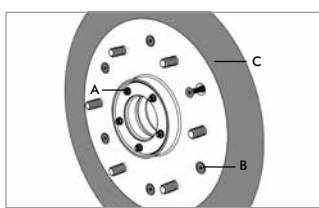

Place the gasket insert into the pipe sleeve/core bore and lightly secure by tightening the nuts (A). Drill dowel holes through the component (10 mm Ø, min. 70 mm deep). Insert the dowels and hexagonal socket screws. Tighten the hexagonal socket screws (B). Smooth out the transition from the fixed flange to the wall with grout (C). Loosen the nuts (A) again.

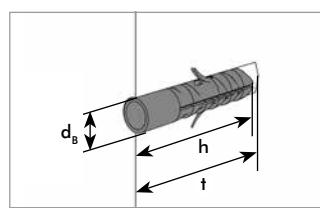

Minimum drill hole depth $d \geq 70$ mm.
Dowel length $h = 50$ mm.
Drill hole diameter $d_B = 10$ mm.

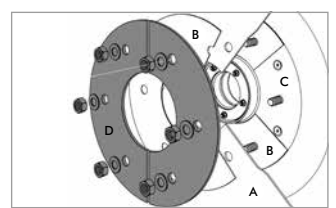

Cut the membrane (A) and necessary packings (B), if any, for loosely laid membranes in accordance with the membrane manufacturer's specifications (use loose flange as template). Position the packings and membrane on the fixed flange (C). When cutting the membrane, ensure that its surface is not damaged in the process. Use a punch to create the holes for the bolts (M12 = 16 mm, M20 = 24 mm). Alternatively, apply ready-to-use Curaflex® 1775 packings (not included in scope of delivery) to both sides of the membrane(s).

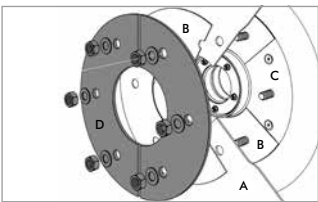

Position the packings and membrane on the fixed flange.
Important: the membrane must not have any kinks, folds, bumps, sticky points or similar in the area around the fixed and loose flange.
Place both halves of the loose flange with the face towards the packing/tanking membrane. Mount the washers and nuts.
*Elastomer packings (according to DIN 18195/DIN 18533) for plastic tanking membranes are available as Curaflex® 1775 accessories.

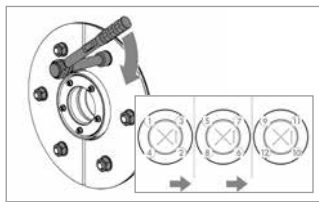

Tighten the nuts, alternating cross-wise with several turns each. See table for torques (excerpt from DIN 18195/DIN 18533 or according to the specifications of the membrane manufacturers).

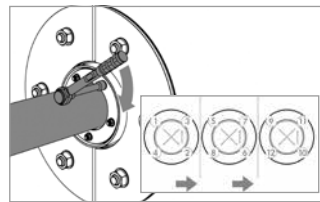

Run the pipe centrally through the gasket insert. Tighten the nuts, alternating cross-wise with several turns each, up to the specified torque at most (see table). If there are multiple rows of bolts, tighten the nuts of the inner row of bolts first. Then tighten the nuts, alternating cross-wise with several turns each.

- Curaflex® C/2/SD/6
- Curaflex® F/2/SD/6
- Curaflex® C/2/SD/5
- Curaflex® F/2/SD/5

Curaflex® C (F) 2/SD/5 or C (F) 2/SD/6 with thick coating

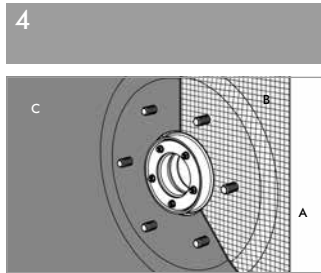

Work steps 1–2b as described above. Apply the first layer of KMB thick coating (A) to the surface to be sealed and to the sanded fixed flange (KMB = plastic-modified bitumen thick coatings). In doing so, observe the guidelines for processing KMB. Insert fleece/reinforcing insert (B) and press lightly into the thick coating. Apply second layer of KMB (C).

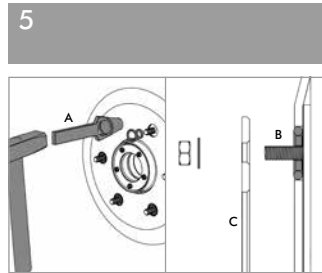

After drying, punch out KMB centrally around the bolts using a punch tool (A) (Ø 40 mm for M12, Ø 55 mm for M20). Insert spacers and O-rings (B). Place both halves of the loose flange (C) with the face or sanded surface towards KMB. Mount the washers and nuts.

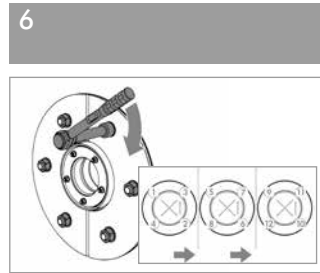

Tighten the nuts, alternating cross-wise with several turns each. See table for torques (excerpt from DIN 18195/DIN 18533 or according to the manufacturer of the thick coating).

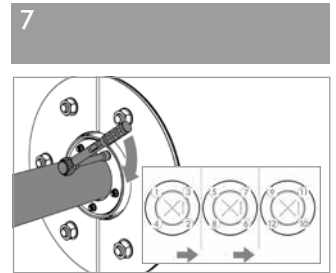

Route the cable centrally through the gasket insert nuts several times, alternating cross-wise, until maximum torque is achieved (see table). If there are multiple rows of bolts, tighten the nuts of the inner row of bolts first. Then tighten the nuts, alternating cross-wise with several turns each.

Max. torques for gasket inserts

Bolt diameter	Width across flats	Curaflex® C/2/SD/6, C/2/SD/5, F/2/SD/6, F/2/SD/5	Curaflex® C/2/SD/6-40, C/2/SD/5-40, F/2/SD/6-40, F/2/SD/5-40
M 5	8	3 Nm	2 Nm
M 6	10	8 Nm	5 Nm
M 8	13	12 Nm	7 Nm
M 10	17	25 Nm	15 Nm
M 12	19	30 Nm	18 Nm

Important!

In the case of thin-walled and/or foamed plastic pipes, reduced torques are needed for the clamping nuts, as otherwise the pipes may be damaged.

Sample recommendation: Tighten sewer headers DN 110 with Curaflex® C(F)/2/SD/5(6) in core bore DN 200 with max. 5 Nm tightening torque. Tighten sewer headers DN 110 with Curaflex® C(F)/2/SD/5(6)-40 in core bore DN 150 with max. 3 Nm tightening torque.

- Curaflex® C/2/SD/6
- Curaflex® F/2/SD/6
- Curaflex® C/2/SD/5
- Curaflex® F/2/SD/5

Guide torque values of the membrane manufacturers
or DIN 18195/DIN 18533 for tightening the loose flange

Type of tanking membrane or thick coating	Torques for M 12 (Nm) Width across flats 19 mm	Torques for M 20 (Nm) Width across flats 30 mm
When using DOYMA Curaflex® 1775 packings for tanking membranes	30	80
For KMB (plastic-modified thick coatings) in combination with DOYMA Curaflex® 1776 accessories	30	100
Bare bitumen membranes according to DIN 52129-R 500	12*	50*
PIB according to DIN 18533-2:2017-06, table 3, line 2	12*	50*
Bitumen and polymer-bitumen membranes according to DIN 18533-2:2017-06, table 1, with reinforcement made of polyester fleece, KTP or copper tape inlay	15*	65*
Bitumen and polymer bitumen membranes according to DIN 18533-2:2017-06, table 1, with reinforcement made of glass fabric or KTP	20*	80*
Bare bitumen membrane DIN 52129 – R 500 N + 1 x °	20*	1st tightening: 100* 2nd and 3rd tightening: 80*
Bitumen-compatible plastic and elastomer membranes according to DIN 18533-2: 2017-06, table 3, excluding line 2	20*	80*
Bare bitumen membrane DIN 52129 – R 500 N + 2 x °	30*	1st tightening: 120* 2nd tightening: 100* 3rd tightening: 80*
Plastic or elastomer membranes according to DIN 18533-2: 2015-12, table 3, loosely laid FLK according to ETAG 005	30*	100*
Elastomer clamp joint tapes – for smooth clamping surface – for ribbed clamping surface with packing of uncured raw rubber, 100 mm wide, not older than 90 days	40* –	165* 165*

* Torques from DIN 18195-9/DIN 18533-1

INSTALLATION NOTES
Curaflex® gasket inserts

- Curaflex® C/2/SD/6
- Curaflex® F/2/SD/6
- Curaflex® C/2/SD/5
- Curaflex® F/2/SD/5

Doyma products are always subject to further development. Technical modifications are made without prior notice.
DOYMA allows a 25 years guarantee. **For more information see www.doyma.com**

DOYMA GmbH & Co

SEALING SYSTEMS

FIRE PROTECTION SYSTEMS

Industriestr. 43-57
28876 Oyten

Phone: + 49 (0) 42 07/91 66-300
Fax: + 49 (0) 42 07/91 66-199

www.doyma.de
info@doyma.de

25
years
guarantee

