

# INSTALLATION INSTRUCTIONS

## Curaflex® Pipe sleeves with fixed flange

- Curaflex® 8000
- Curaflex® 8000/T

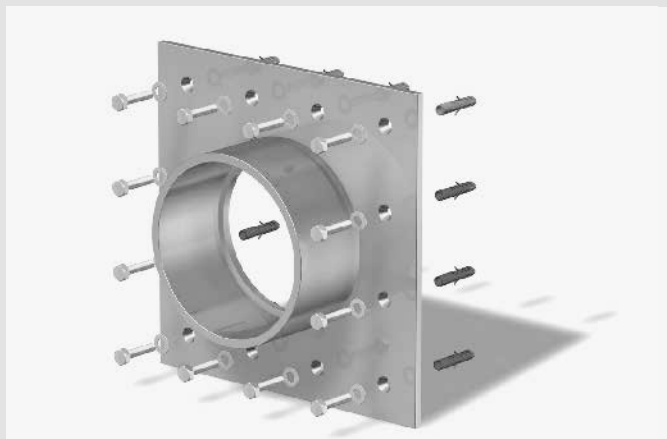

Curaflex® 8000



Curaflex® 8000/T

### Intended use

Steel pipe sleeve for flange-mounting to the wall, to the ceiling/floor slab/sole; to accommodate a gasket insert.

### Curaflex® 8000, 8000/T:

Application for water impermeable walls (white tank), for example, WR concrete for pressing or non-pressing water. Application for buildings with thick coating (black tank) for non-pressing water/soil moisture (not according to DIN 18195/DIN 18533). Prerequisite: The pipe sleeve must be sanded.

### Curaflex® 8000/T:

application for the subsequent assembly for an already laid pipe/cable (split version Ausführung).

### Please note:

- For sealing the annular space between the pipe/cable and pipe sleeve you will need a sealing element. We recommend installing a Curaflex® gasket insert set. If the line has already been laid, the steel casing must be positioned and fixed centrally around the line before dowelling.

### Scope of delivery

- Curaflex® pipe sleeve (in case of a utilization of thick coating in sanded version)
- for sanded Curaflex® Pipe sleeves additionally with fiber glass matting
- Fixing material for fixing the pipe sleeve
- Installation instructions

### Required accessories, but not included

(applies to all Curaflex® pipe sleeves in this EBA, except for Curaflex® 8000 sanded):

- Sika adhesive clear 1 (Curaflex® 1754)
- Sika Primer-3 N primer (Curaflex® 1755)
- Sikaflex-11 FC+ (Curaflex® 1756) Countersunk screws (required for use with KMB/PMBC)
- Gasket insert: Curaflex® or Curaflex® Nova

### Installation conditions

The wall must be clean, level and dry in the installation area. There may be no grooves or cut-outs on the wall surface in the installation area. The steel pipe sleeve must be clean, free of dust and grease. If there is a pipe sleeve in the wall, it must terminate flush with the wall. The diameter of the core boring/wall lining pipe must be smaller than the pipe sleeve of the steel pipe sleeve. If the pipe/cable is not centric to the steel pipe sleeve, a special design may be necessary after a consultation.

With regard to the "thick coating application case", distances for flange constructions according to DIN 18195/DIN 18533 are normally to be arranged as follows: Flange to flange or to other components, e.g. building edges/conduits, wall connections, min. 150 mm with non pressing water. Expansion joints: With non pressing water, distances of at least 300 mm must be maintained unless a larger distance is required for processing reasons.

## Installation steps

### Curaflex® 8000

#### 1 Draw dowel hole

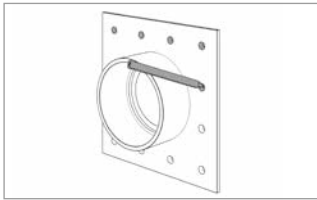

Position the steel pipe sleeve on the wall and mark dowel holes.  
**Important:** If the duct is already installed, position the pipe sleeve centrally to the duct!

#### 2 Drill dowel holes

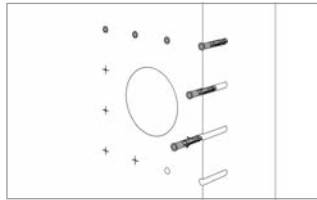

Drill the dowel holes, and insert the dowels.

#### 3 Boring holes for fixed flange

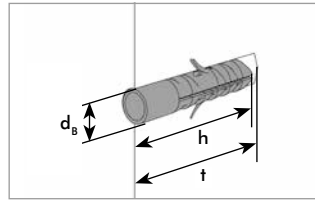

Minimum drill hole depth  $t \geq 70$  mm  
Dowel length  $h = 50$  mm  
Bore/hole diameter  $d_b = 10$  mm

#### 4 Primer Sika Apply Primer 3N

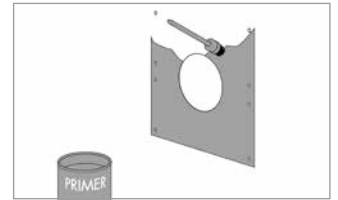

Pre-treat the wall with Sika Primer-3 N. Apply with a brush in the installation area of the steel pipe sleeve.

#### 5 Apply Sika adhesive cleaner 1

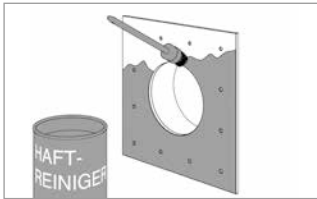

Pretreatment of the steel pipe sleeve with Sika Adhesion Cleaner-1. Apply to the back of the steel plate (against the sleeve) using a brush or cloth.

#### 6 Apply Sikaflex-11 FC+



Apply the Sikaflex-11 FC+ pressure-tight adhesive (PTA) to the wall. Apply PTA spiderweb-like onto the wall in the installation area of the steel pipe sleeve. Continuous PTA sheets are a prerequisite for durable sealing.

#### 7a/b Position the pipe sleeve on the wall

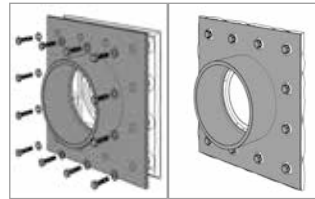

Assembly of the steel pipe sleeve on the wall by setting and tightening the screws.  
**Note:** The mounting is correct if the PTA swells out around the inside and outside and from all boring holes in the plate when tightening the screws.

#### 8 Check PTA

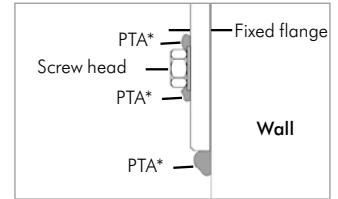

**Important:** \* swelling out PTA

### Curaflex® 8000 for bitumen thick coatings (KMB/PMBC)

#### 1-7 work steps see the above

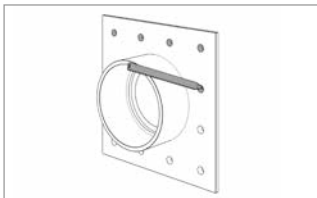

Perform steps 1-7 as before.

#### 8 Compensation with mortar

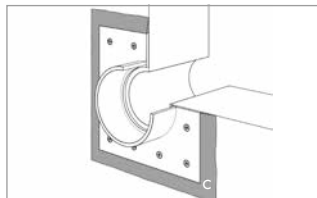

Compensation of the transition from the fixed flange to the wall with mortar (C).

#### 9 Application of the thick coating

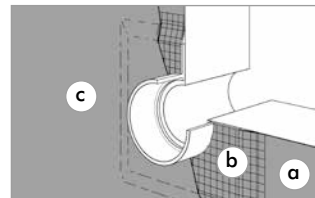

- Apply the first layer of the KMB/PMBC (a) on the surface to be sealed and apply the sanded fixed flange. Observe the guidelines for processing the KMB/PMBC used.  
- Insert fibre glass matting (b) and press it lightly into the thick coating.  
- Apply the second layer of the KMB/PMBC (c).

**Note:**  
When used with KMB/PMBC, counter-sunk screws are necessary for mounting the steel pipe sleeve to the wall (included in the scope of delivery).

**Curaflex® 8000/T**

**1 Draw dowel hole**

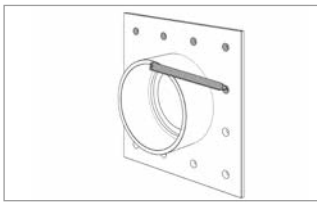

Position the steel pipe sleeve mounted together on the wall, and mark the dowel holes.

**Important:** If the duct is already installed, position the pipe sleeve centrally to the duct!

**2 Drill dowel holes**

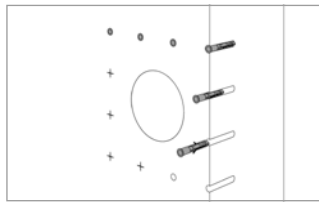

Drill the dowel holes, and insert the dowels.

**3 Boring holes for fixed flange**

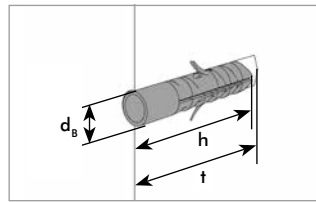

Minimum drill hole depth  $t \geq 70$  mm  
Dowel length  $h = 50$  mm  
Bore/hole diameter  $d_b = 10$  mm

**4 Primer Sika Apply Primer 3N**

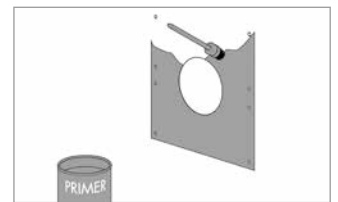

Pre-treat the wall with Sika Primer-3 N. Apply with a brush in the installation area of the steel pipe sleeve.

**5 Apply Sika Adhesion Cleaner-1**

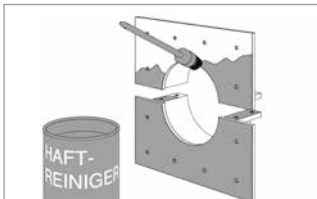

Pretreatment of the steel pipe sleeve with Sika Adhesion Cleaner-1. Apply to the back of the steel plate (against the sleeve) and to the dividing plates using a brush or cloth.

**6 Apply Sikaflex-11 FC+**



Apply the pressure-tight adhesive (PTA) Sikaflex-11 FC+ to the wall. Apply PTA spiderweb-like onto the wall in the installation area of the steel pipe sleeve, and to the partitioning tabs. Screw together the steel pipe sleeve halves with the mounting set. Continuous PTA sheets are a prerequisite for durable sealing.

**7a/b Position the pipe sleeve on the wall**

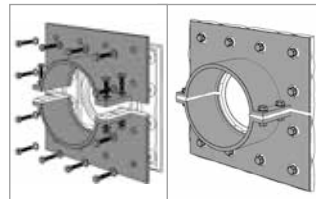

Assembly of the steel pipe sleeve on the wall by setting and tightening the screws. **Note:** The mounting is correct if the PTA swells out around the inside and outside and from all boring holes and the partitioning tabs of the plate when tightening the screws.

**8 Check PTA**

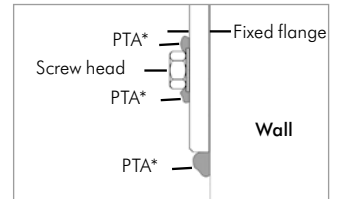

**Important:** \* swelling out PTA

**Curaflex® 8000/T for bitumen thick coatings (KMB/PMBC)**

**1-7 work steps see the above**

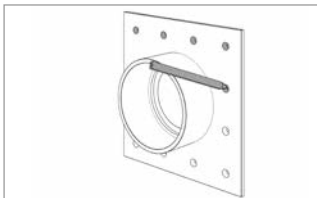

Position the steel pipe sleeve mounted together on the wall, and mark the dowel holes.

**Important:** If the duct is already installed, position the pipe sleeve centrally to the duct!

**8 Compensation with mortar**

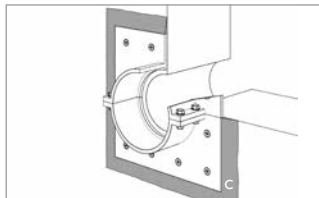

Compensation of the transition from the fixed flange to the wall with mortar (C).

**9 Application of the thick coating**

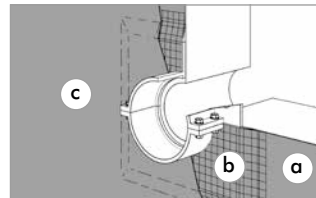

**Work steps 2-8 see above as before**

- Apply the first layer of the KMB/PMBC (a) on the surface to be sealed and apply the sanded fixed flange. Observe the guidelines for processing the KMB/PMBC used.
- Insert fibre glass matting (b) and press it lightly into the thick coating.
- Apply the second layer of the KMB/PMBC (c).

**Note:** When used with KMB/PMBC, counter-sunk screws are necessary for mounting the steel pipe sleeve to the wall (included in the scope of delivery).

## Curaflex® 8000/8000T for other waterproofing materials

**Note:**

The use and processing must be agreed and carried out in consultation with the manufacturers of the respective sealing systems.

DOYMA products are continuously being further developed. Technical changes will be performed without prior notice.  
25 year warranty on all DOYMA products. **More information at [www.doyma.de](http://www.doyma.de)**

---

### DOYMA GmbH & Co

SEALING SYSTEMS  
FIRE PROTECTION SYSTEMS

Industriestr. 43-57  
28876 Oyten

Phone: 0 42 07/91 66-300  
Fax: 0 42 07/91 66-199

[www.doyma.de](http://www.doyma.de)  
[info@doyma.de](mailto:info@doyma.de)

---

25  
years  
guarantee

